

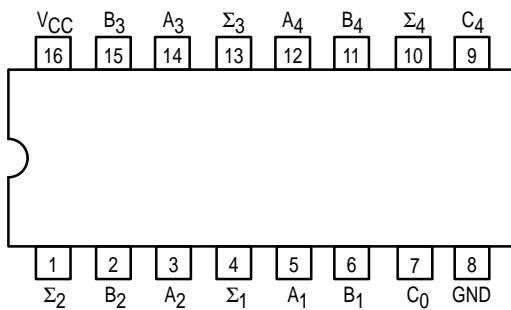

# 4-BIT BINARY FULL ADDER WITH FAST CARRY

The SN54/74LS283 is a high-speed 4-Bit Binary Full Adder with internal carry lookahead. It accepts two 4-bit binary words ( $A_1-A_4$ ,  $B_1-B_4$ ) and a Carry Input ( $C_0$ ). It generates the binary Sum outputs ( $\Sigma_1-\Sigma_4$ ) and the Carry Output ( $C_4$ ) from the most significant bit. The LS283 operates with either active HIGH or active LOW operands (positive or negative logic).

CONNECTION DIAGRAM DIP (TOP VIEW)



NOTE:  
The Flatpak version has the same pinouts (Connection Diagram) as the Dual In-Line Package.

**PIN NAMES**

- $A_1-A_4$  Operand A Inputs
- $B_1-B_4$  Operand B Inputs
- $C_0$  Carry Input
- $\Sigma_1-\Sigma_4$  Sum Outputs (Note b)
- $C_4$  Carry Output (Note b)

**LOADING** (Note a)

	HIGH	LOW
$A_1-A_4$	1.0 U.L.	0.5 U.L.
$B_1-B_4$	1.0 U.L.	0.5 U.L.
$C_0$	0.5 U.L.	0.25 U.L.
$\Sigma_1-\Sigma_4$	10 U.L.	5 (2.5) U.L.
$C_4$	10 U.L.	5 (2.5) U.L.

NOTES:

- a) 1 TTL Unit Load (U.L.) = 40  $\mu$ A HIGH/1.6 mA LOW.
- b) The Output LOW drive factor is 2.5 U.L. for Military (54) and 5 U.L. for Commercial (74) Temperature Ranges.

## SN54/74LS283

**4-BIT BINARY FULL ADDER WITH FAST CARRY**  
**LOW POWER SCHOTTKY**

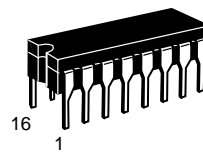

**J SUFFIX**  
CERAMIC  
CASE 620-09

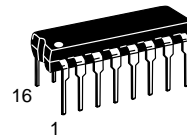

**N SUFFIX**  
PLASTIC  
CASE 648-08

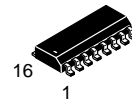

**D SUFFIX**  
SOIC  
CASE 751B-03

**ORDERING INFORMATION**

- SN54LSXXXJ Ceramic
- SN74LSXXXN Plastic
- SN74LSXXXD SOIC

**LOGIC SYMBOL**

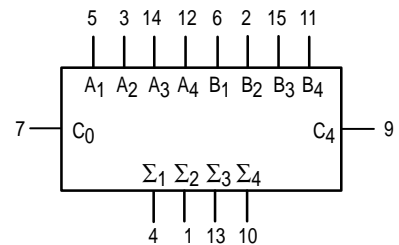

$V_{CC}$  = PIN 16  
 $GND$  = PIN 8

# SN54/74LS283

## LOGIC DIAGRAM

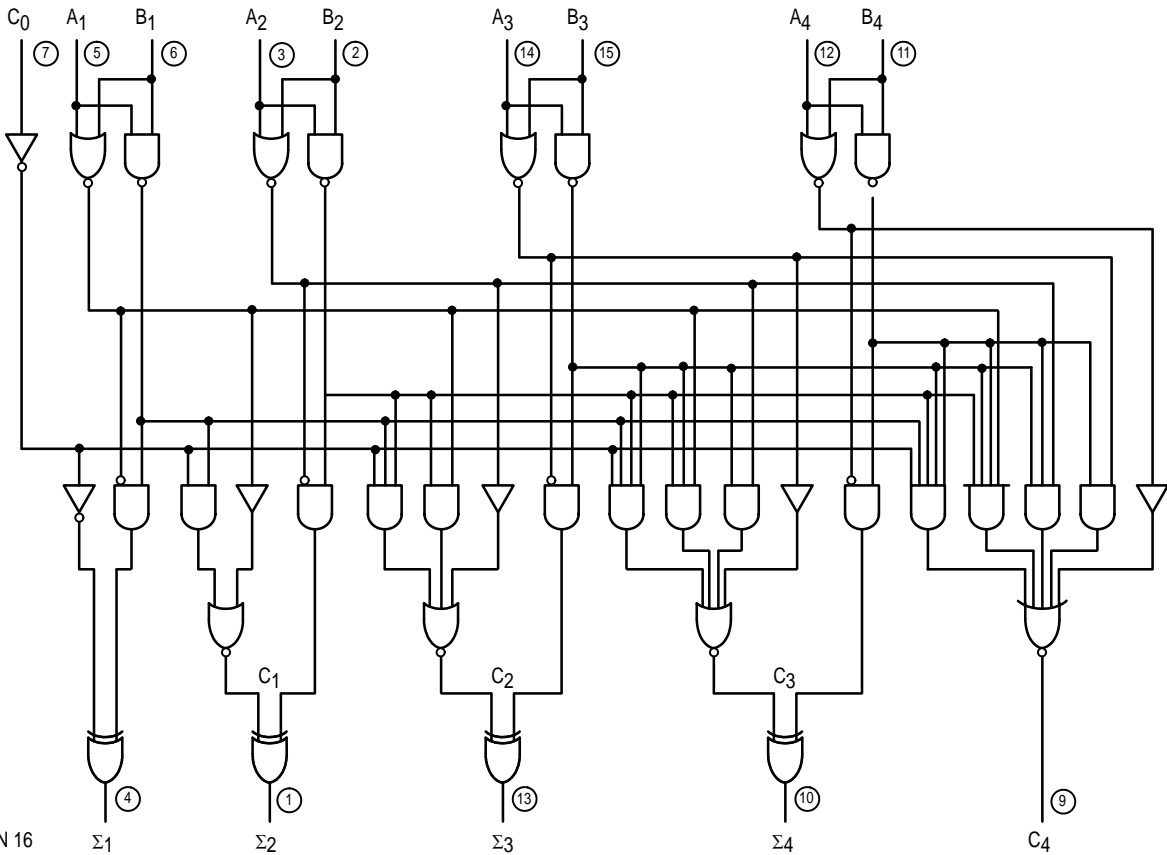

$V_{CC}$  = PIN 16  
 GND = PIN 8  
 ○ = PIN NUMBERS

## FUNCTIONAL DESCRIPTION

The LS283 adds two 4-bit binary words (A plus B) plus the incoming carry. The binary sum appears on the sum outputs ( $\Sigma_1 - \Sigma_4$ ) and outgoing carry ( $C_4$ ) outputs.

$$C_0 + (A_1 + B_1) + 2(A_2 + B_2) + 4(A_3 + B_3) + 8(A_4 + B_4) = \Sigma_1 + 2\Sigma_2 + 4\Sigma_3 + 8\Sigma_4 + 16C_4$$

Where: (+) = plus

Due to the symmetry of the binary add function the LS283 can be used with either all inputs and outputs active HIGH (positive logic) or with all inputs and outputs active LOW (negative logic). Note that with active HIGH inputs, Carry Input can not be left open, but must be held LOW when no carry in is intended.

### Example:

	$C_0$	$A_1$	$A_2$	$A_3$	$A_4$	$B_1$	$B_2$	$B_3$	$B_4$	$\Sigma_1$	$\Sigma_2$	$\Sigma_3$	$\Sigma_4$	$C_4$
logic levels	L	L	H	L	H	H	L	L	H	H	H	L	L	H
Active HIGH	0	0	1	0	1	1	0	0	1	1	1	0	0	1
Active LOW	1	1	0	1	0	0	1	1	0	0	0	1	1	0

(10+9=19)  
 (carry+5+6=12)

Interchanging inputs of equal weight does not affect the operation, thus  $C_0$ ,  $A_1$ ,  $B_1$ , can be arbitrarily assigned to pins 7, 5 or 3.

# SN54/74LS283

FUNCTIONAL TRUTH TABLE

C (n-1)	A <sub>n</sub>	B <sub>n</sub>	Σ <sub>n</sub>	C <sub>n</sub>
L	L	L	L	L
L	L	H	H	L
L	H	L	H	L
L	H	H	L	H
H	L	L	H	L
H	L	H	L	H
H	H	L	L	H
H	H	H	H	H

C<sub>1</sub> – C<sub>3</sub> are generated internally  
 C<sub>0</sub> is an external input  
 C<sub>4</sub> is an output generated internally

## GUARANTEED OPERATING RANGES

Symbol	Parameter		Min	Typ	Max	Unit
V <sub>CC</sub>	Supply Voltage	54 74	4.5 4.75	5.0 5.0	5.5 5.25	V
T <sub>A</sub>	Operating Ambient Temperature Range	54 74	-55 0	25 25	125 70	°C
I <sub>OH</sub>	Output Current — High	54, 74			-0.4	mA
I <sub>OL</sub>	Output Current — Low	54 74			4.0 8.0	mA

## DC CHARACTERISTICS OVER OPERATING TEMPERATURE RANGE (unless otherwise specified)

Symbol	Parameter	Limits			Unit	Test Conditions	
		Min	Typ	Max			
V <sub>IH</sub>	Input HIGH Voltage	2.0			V	Guaranteed Input HIGH Voltage for All Inputs	
V <sub>IL</sub>	Input LOW Voltage	54		0.7	V	Guaranteed Input LOW Voltage for All Inputs	
		74		0.8			
V <sub>IK</sub>	Input Clamp Diode Voltage		-0.65	-1.5	V	V <sub>CC</sub> = MIN, I <sub>IN</sub> = -18 mA	
V <sub>OH</sub>	Output HIGH Voltage	54	2.5	3.5	V	V <sub>CC</sub> = MIN, I <sub>OH</sub> = MAX, V <sub>IN</sub> = V <sub>IH</sub> or V <sub>IL</sub> per Truth Table	
		74	2.7	3.5	V		
V <sub>OL</sub>	Output LOW Voltage	54, 74		0.25	0.4	V	I <sub>OL</sub> = 4.0 mA V <sub>CC</sub> = V <sub>CC</sub> MIN, V <sub>IN</sub> = V <sub>IL</sub> or V <sub>IH</sub> per Truth Table
		74		0.35	0.5	V	
I <sub>IH</sub>	Input HIGH Current	C <sub>0</sub>			20	μA	V <sub>CC</sub> = MAX, V <sub>IN</sub> = 2.7 V
		Any A or B			40	μA	
		C <sub>0</sub>			0.1	mA	V <sub>CC</sub> = MAX, V <sub>IN</sub> = 7.0 V
		Any A or B			0.2	mA	
I <sub>IL</sub>	Input LOW Current	C <sub>0</sub>			-0.4	mA	V <sub>CC</sub> = MAX, V <sub>IN</sub> = 0.4 V
		Any A or B			-0.8	mA	
I <sub>OS</sub>	Short Circuit Current (Note 1)	-20		-100	mA	V <sub>CC</sub> = MAX	
I <sub>CC</sub>	Power Supply Current Total, Output HIGH			34	mA	V <sub>CC</sub> = MAX	
	Total, Output LOW			39			

Note 1: Not more than one output should be shorted at a time, nor for more than 1 second.

# SN54/74LS283

AC CHARACTERISTICS ( $T_A = 25^\circ\text{C}$ ,  $V_{CC} = 5.0\text{ V}$ )

Symbol	Parameter	Limits			Unit	Test Conditions
		Min	Typ	Max		
t <sub>PLH</sub> t <sub>PHL</sub>	Propagation Delay, C <sub>0</sub> Input to Any $\Sigma$ Output		16 15	24 24	ns	C <sub>L</sub> = 15 pF Figures 1 & 2
t <sub>PLH</sub> t <sub>PHL</sub>	Propagation Delay, Any A or B Input to $\Sigma$ Outputs		15 15	24 24	ns	
t <sub>PLH</sub> t <sub>PHL</sub>	Propagation Delay, C <sub>0</sub> Input to C <sub>4</sub> Output		11 11	17 22	ns	
t <sub>PLH</sub> t <sub>PHL</sub>	Propagation Delay, Any A or B Input to C <sub>4</sub> Output		11 12	17 17	ns	

## AC WAVEFORMS

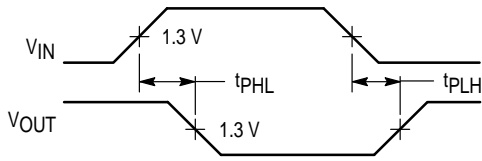

Figure 1

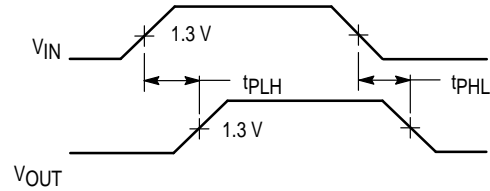

Figure 2